

DATA SHEET

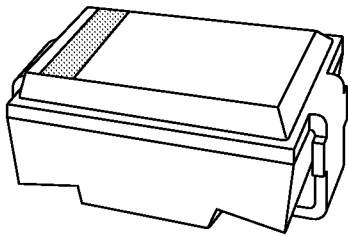

US1 series SMA ultra fast low-loss controlled avalanche rectifiers

Product specification

2000 Feb 14

SMA ultra fast low-loss controlled avalanche rectifiers

US1 series

FEATURES

- Glass passivated
- High maximum operating temperature
- Ideal for surface mount automotive applications
- Low leakage current
- Excellent stability
- Guaranteed avalanche energy absorption capability
- UL 94V-O classified plastic package
- Shipped in 12 mm embossed tape
- Marking: cathode, date code, type code
- Easy pick and place.

DESCRIPTION

DO-214AC surface mountable package with glass passivated chip.

The well-defined void-free case is of a transfer-moulded thermo-setting plastic. The small rectangular package has two J bent leads.

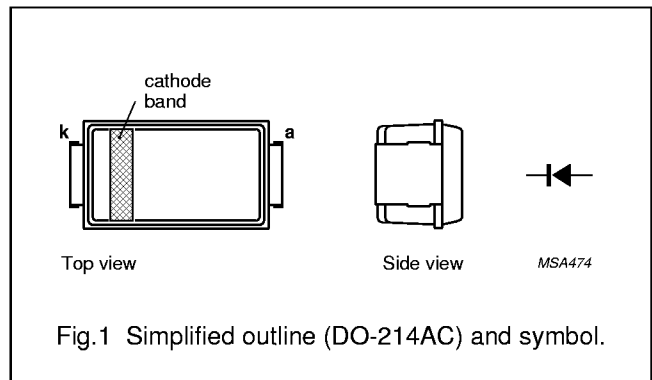

LIMITING VALUES

In accordance with the Absolute Maximum Rating System (IEC 134).

SYMBOL	PARAMETER	CONDITIONS	MIN.	MAX.	UNIT
V _{RRM}	repetitive peak reverse voltage				
	US1A		–	50	V
	US1B		–	100	V
	US1D		–	200	V
	US1G		–	400	V
	US1J		–	600	V
V _R	continuous reverse voltage				
	US1A		–	50	V
	US1B		–	100	V
	US1D		–	200	V
	US1G		–	400	V
	US1J		–	600	V
V _{RMS}	root mean square voltage				
	US1A		–	35	V
	US1B		–	70	V
	US1D		–	140	V
	US1G		–	280	V
	US1J		–	420	V
I _{F(AV)}	average forward current	averaged over any 20 ms period; T _{tp} = 110 °C; see Fig.2	–	1	A

SMA ultra fast low-loss controlled avalanche rectifiers

US1 series

SYMBOL	PARAMETER	CONDITIONS	MIN.	MAX.	UNIT
I_{FSM}	non-repetitive peak forward current	$t = 8.3$ ms half sine wave; $T_j = 25$ °C prior to surge; $V_R = V_{RRMmax}$	–	25	A
T_{stg}	storage temperature		–65	+175	°C
T_j	junction temperature	See Fig.3	–65	+175	°C

ELECTRICAL CHARACTERISTICS

$T_j = 25$ °C unless otherwise specified.

SYMBOL	PARAMETER	CONDITIONS	TYP.	MAX.	UNIT
V_F	forward voltage	$I_F = 1$ A; see Fig.4	–	1.1	V
	US1A to US1G				
	US1J	see Fig.5	–	1.4	V
I_R	reverse current	$V_R = V_{RRMmax}$; see Figs 6 and 7	–	10	µA
		$V_R = V_{RRMmax}$; $T_j = 165$ °C; see Figs 6 and 7	–	50	µA
t_{rr}	reverse recovery time	when switched from $I_F = 0.5$ A to $I_R = 1$ A; measured at $I_R = 0.25$ A; see Fig.12	–	50	ns
C_d	diode capacitance	$V_R = 4$ V; $f = 1$ MHz; see Fig.8	14	–	pF
	US1A to US1G				
	US1J	see Fig.9	10	–	pF

THERMAL CHARACTERISTICS

SYMBOL	PARAMETER	CONDITIONS	VALUE	UNIT
$R_{th\ j-tp}$	thermal resistance from junction to tie-point; see Fig.10		27	K/W
$R_{th\ j-a}$	thermal resistance from junction to ambient	note 1	100	K/W
		note 2	150	K/W

Notes

1. Device mounted on Al_2O_3 printed-circuit board, 0.7 mm thick; thickness of copper ≥ 35 µm.
2. Device mounted on epoxy-glass printed-circuit board, 1.5 mm thick; thickness of copper ≥ 40 µm. For more information please refer to the 'General Part of associated Handbook'.

SMA ultra fast low-loss
controlled avalanche rectifiers

US1 series

GRAPHICAL DATA

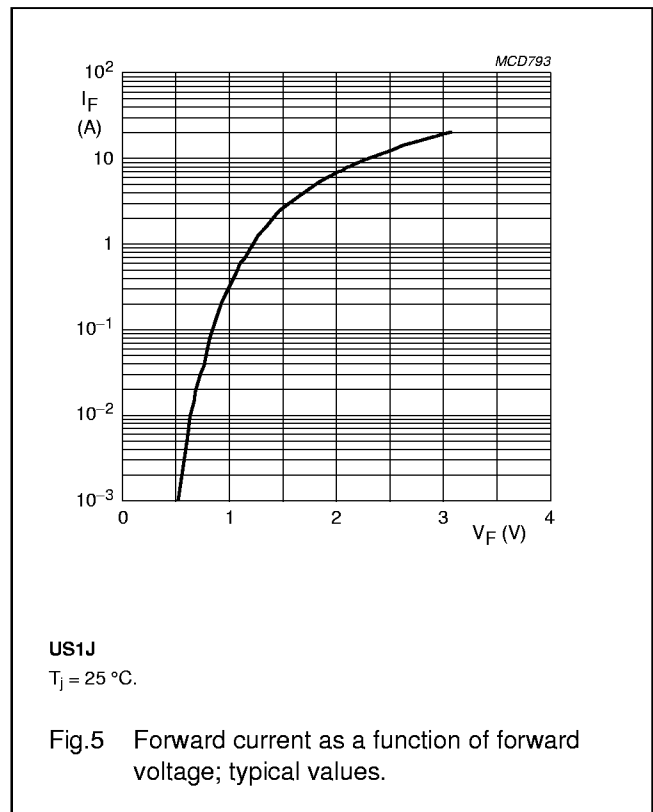
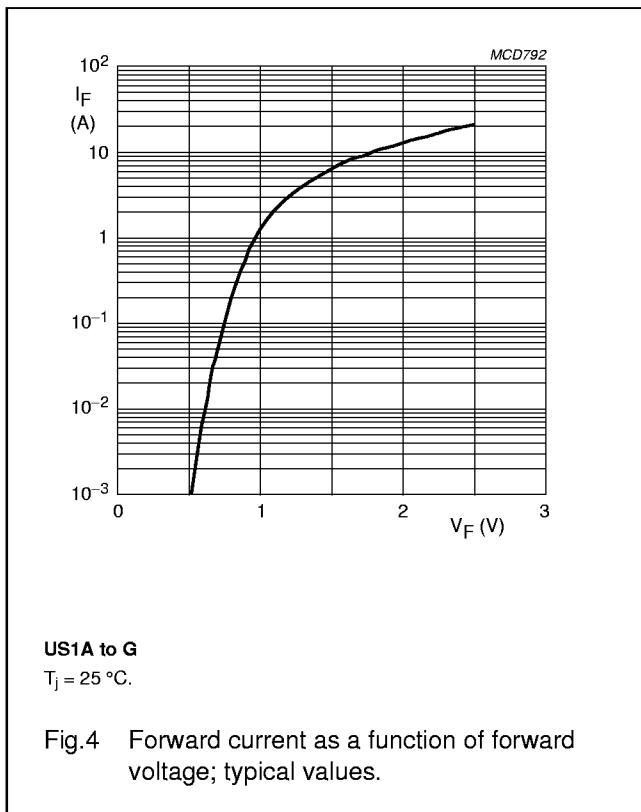
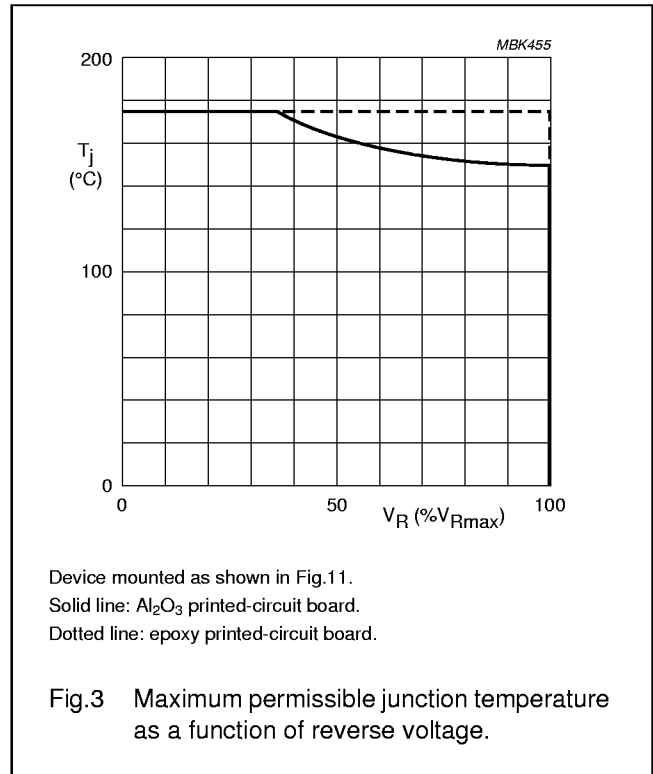
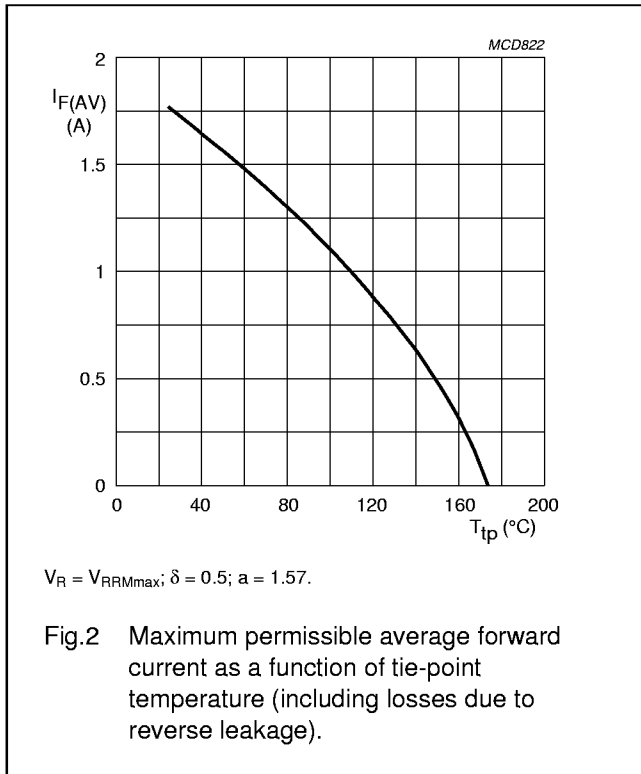

SMA ultra fast low-loss
controlled avalanche rectifiers

US1 series

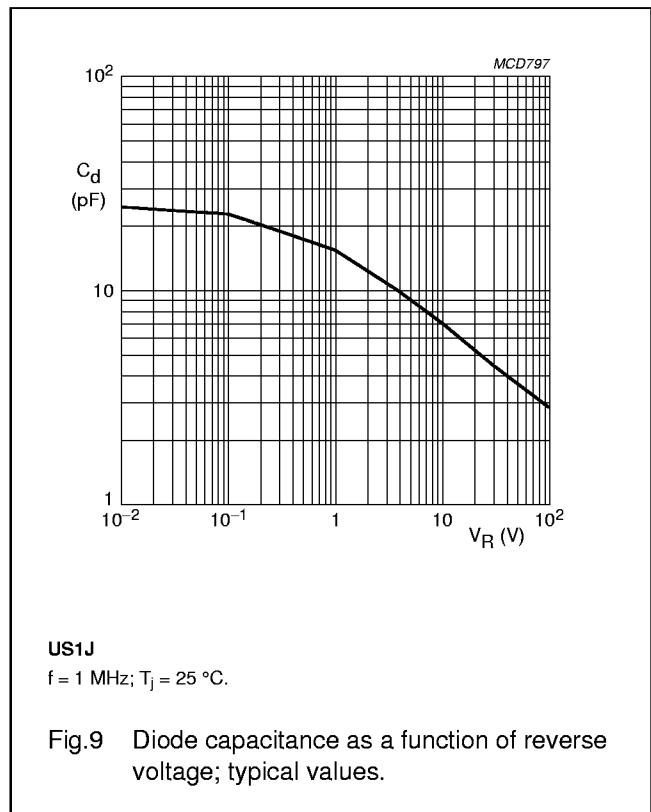
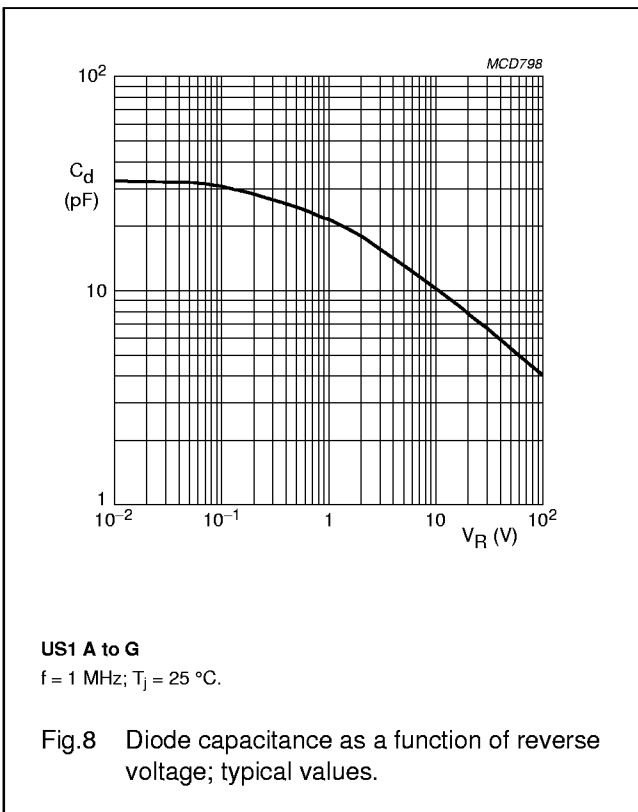
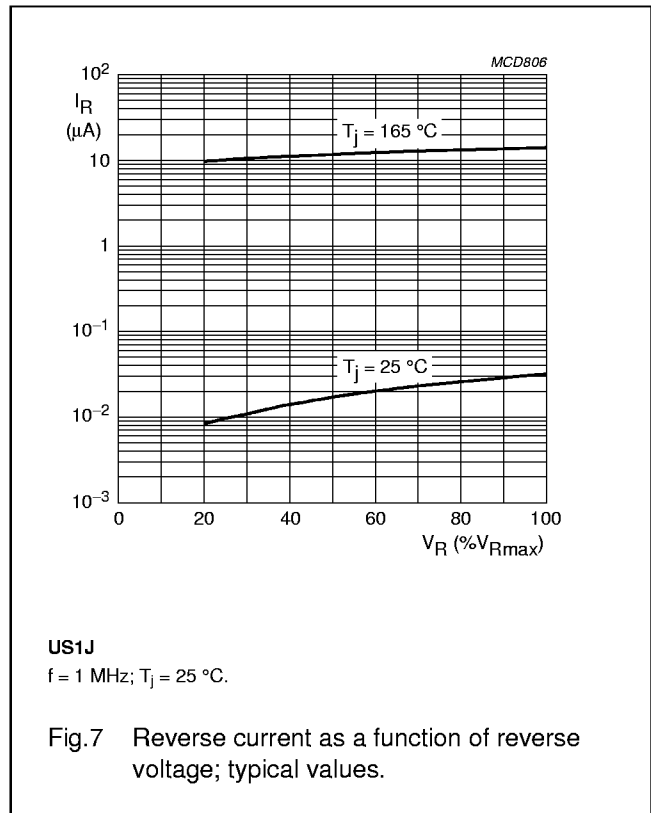
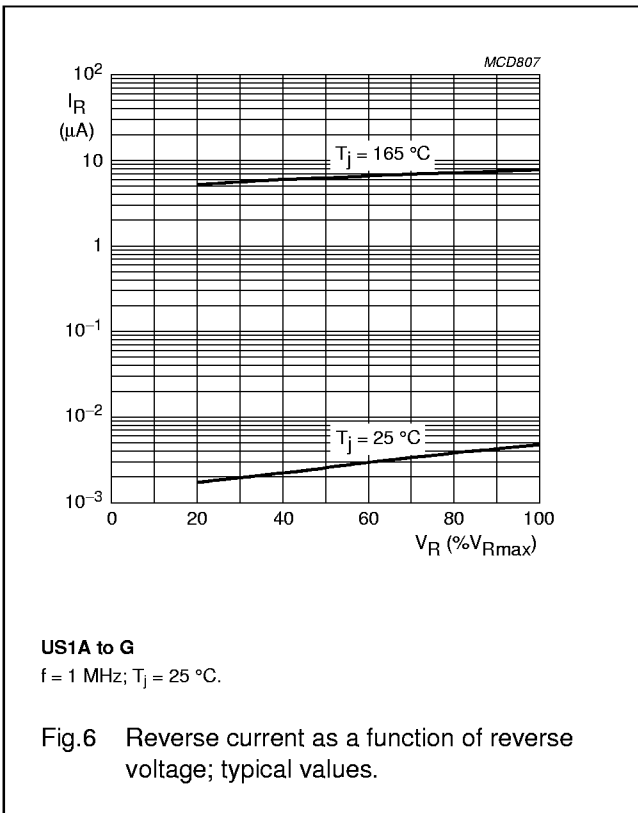

SMA ultra fast low-loss controlled avalanche rectifiers

US1 series

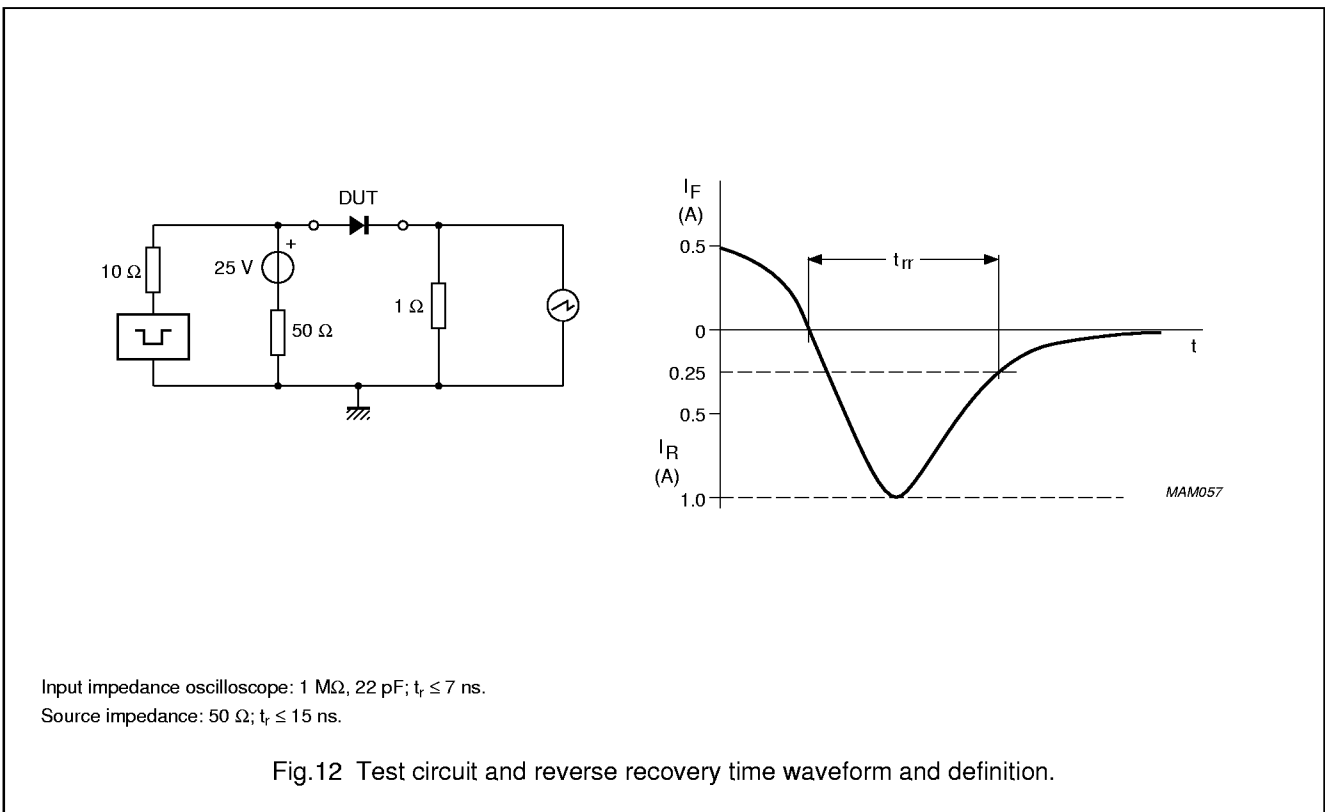
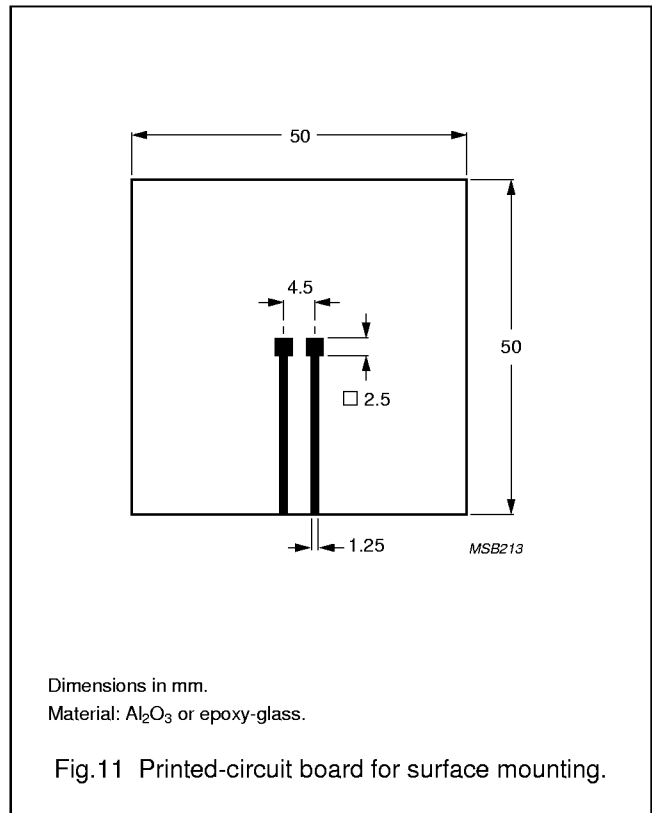
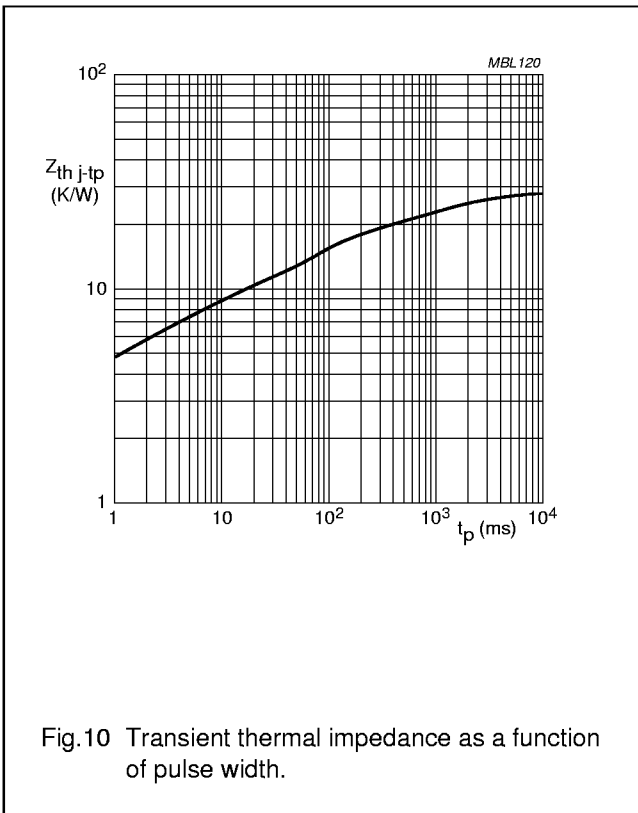

SMA ultra fast low-loss
controlled avalanche rectifiers

US1 series

PACKAGE OUTLINE

Transfer-moulded thermo-setting plastic small rectangular surface mounted package;
2 connectors

SOD124

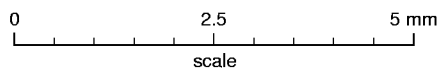
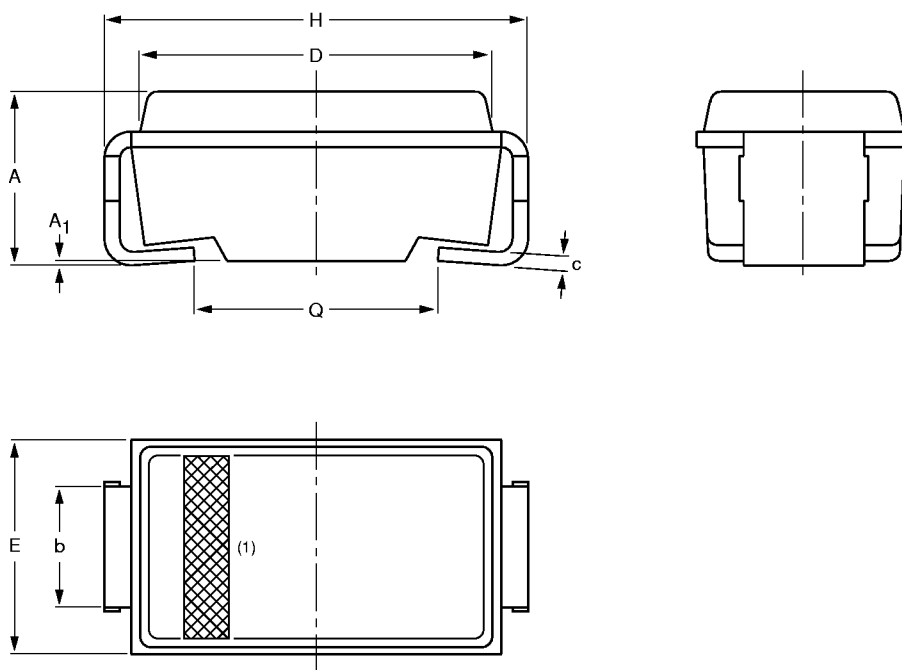

DIMENSIONS (mm are the original dimensions)

UNIT	A	A ₁	b	c	D	E	H	Q
mm	2.3 2.0	0.05	1.6 1.4	0.2	4.5 4.3	2.8 2.4	5.5 5.1	3.3 2.7

Note

1. The marking band indicates the cathode.

OUTLINE VERSION	REFERENCES				EUROPEAN PROJECTION	ISSUE DATE
	IEC	JEDEC	EIAJ			
SOD124		DO-214AC				99-10-22

SMA ultra fast low-loss controlled avalanche rectifiers

US1 series

DEFINITIONS

Data sheet status	
Objective specification	This data sheet contains target or goal specifications for product development.
Preliminary specification	This data sheet contains preliminary data; supplementary data may be published later.
Product specification	This data sheet contains final product specifications.
Limiting values	
Limiting values given are in accordance with the Absolute Maximum Rating System (IEC 60134). Stress above one or more of the limiting values may cause permanent damage to the device. These are stress ratings only and operation of the device at these or at any other conditions above those given in the Characteristics sections of the specification is not implied. Exposure to limiting values for extended periods may affect device reliability.	
Application information	
Where application information is given, it is advisory and does not form part of the specification.	

LIFE SUPPORT APPLICATIONS

These products are not designed for use in life support appliances, devices, or systems where malfunction of these products can reasonably be expected to result in personal injury. Philips customers using or selling these products for use in such applications do so at their own risk and agree to fully indemnify Philips for any damages resulting from such improper use or sale.